

# II Seminário Hospitais Saudáveis

Otimização de insumos básicos em um hospital

Renato Kaida

14 outubro 2009



**HOSPITAL  
SÍRIO-LIBANÊS**

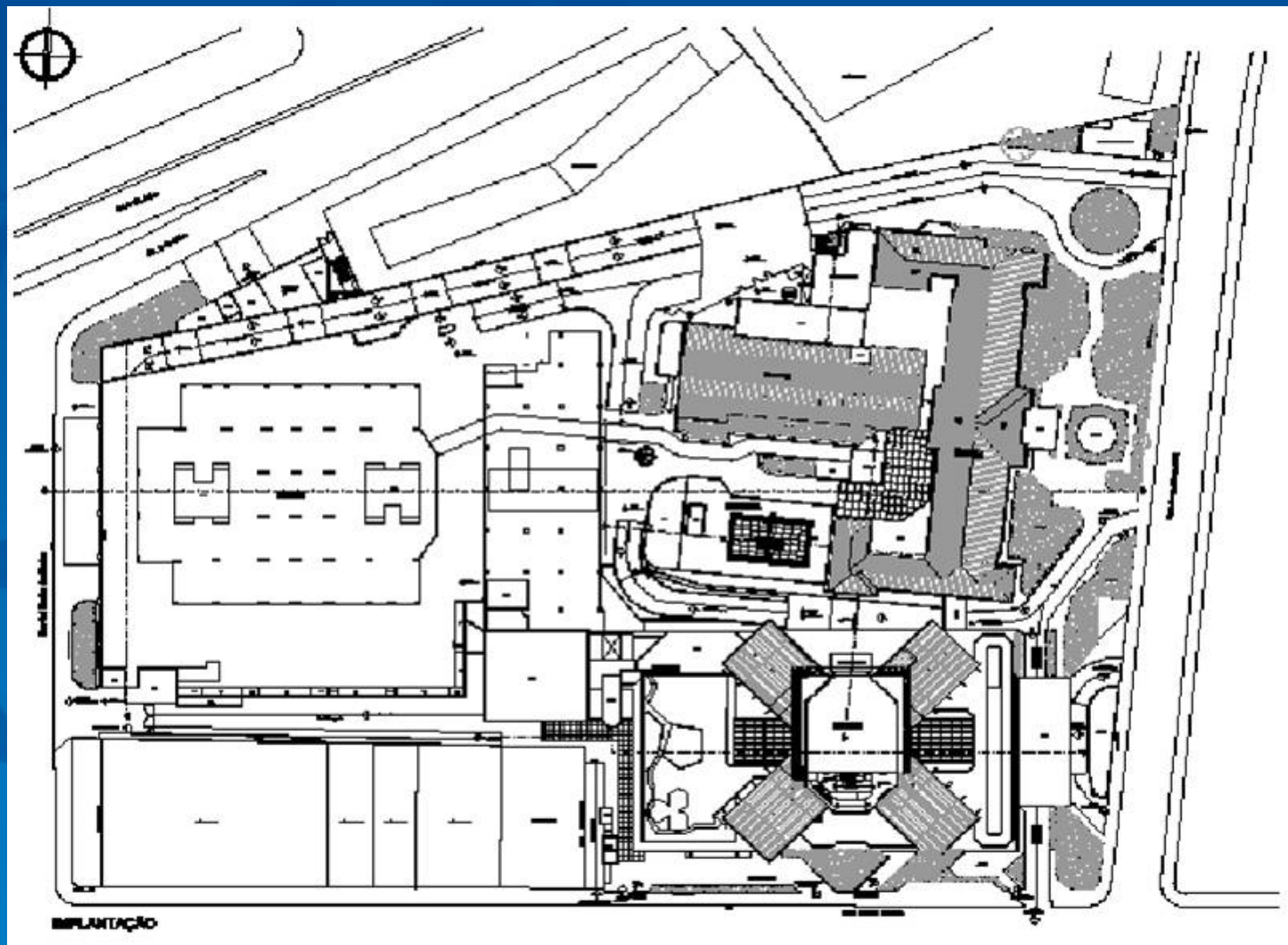

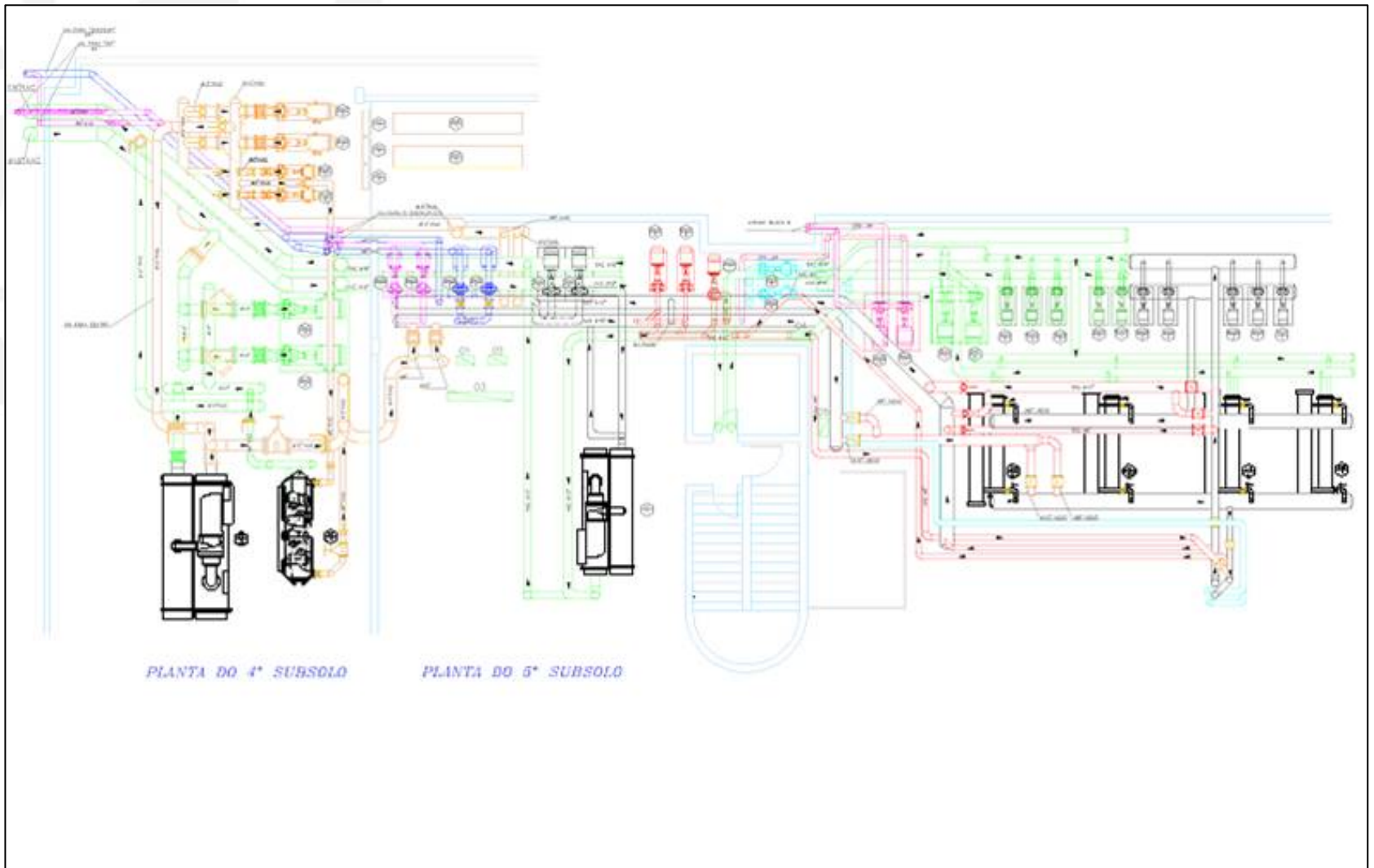















## ◆ Equipamentos

- ◆ 01 x Chiller Centrífugo Modelo **CVGF 720 TR** com controlador CH 530.
- ◆ 01 x Chiller Centrífugo Modelo **CVHF 1000 TR** com controlador CH 530.
- ◆ 01 x Chiller Parafuso Modelo **Hitachi 300 TR**.
- ◆ 06 x Bombas de água gelada do anel primário (BAGP).
- ◆ 11 x Bombas de água gelada do anel secundário (BAGS), com Variador de Frequência.
- ◆ 04 x Bombas de água condensação (BAC).
- ◆ 03 x Ventiladores da Torre, com Variador de Frequência.



## Fluxograma Água Gelada

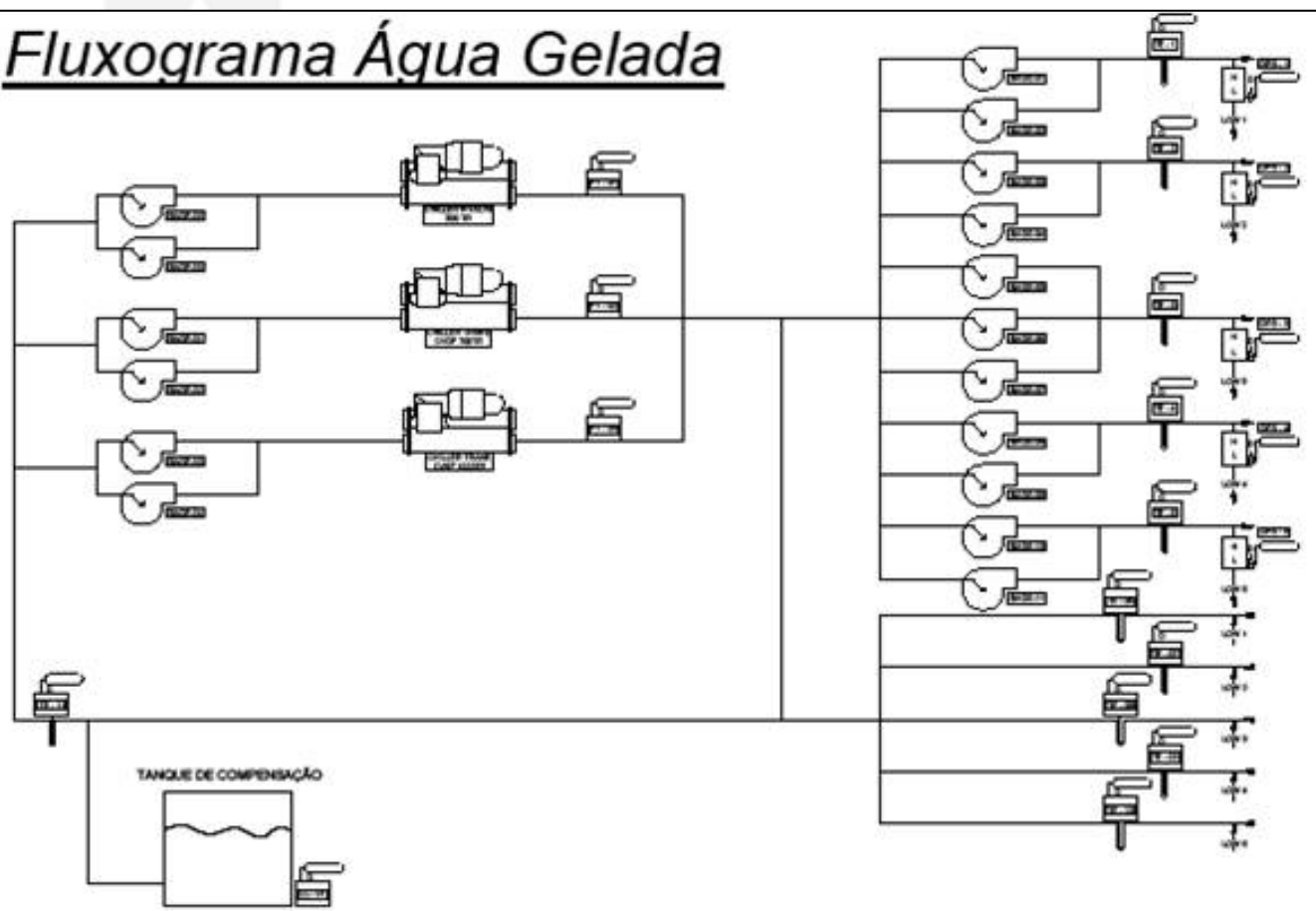

## Fluxograma Água de Condensação

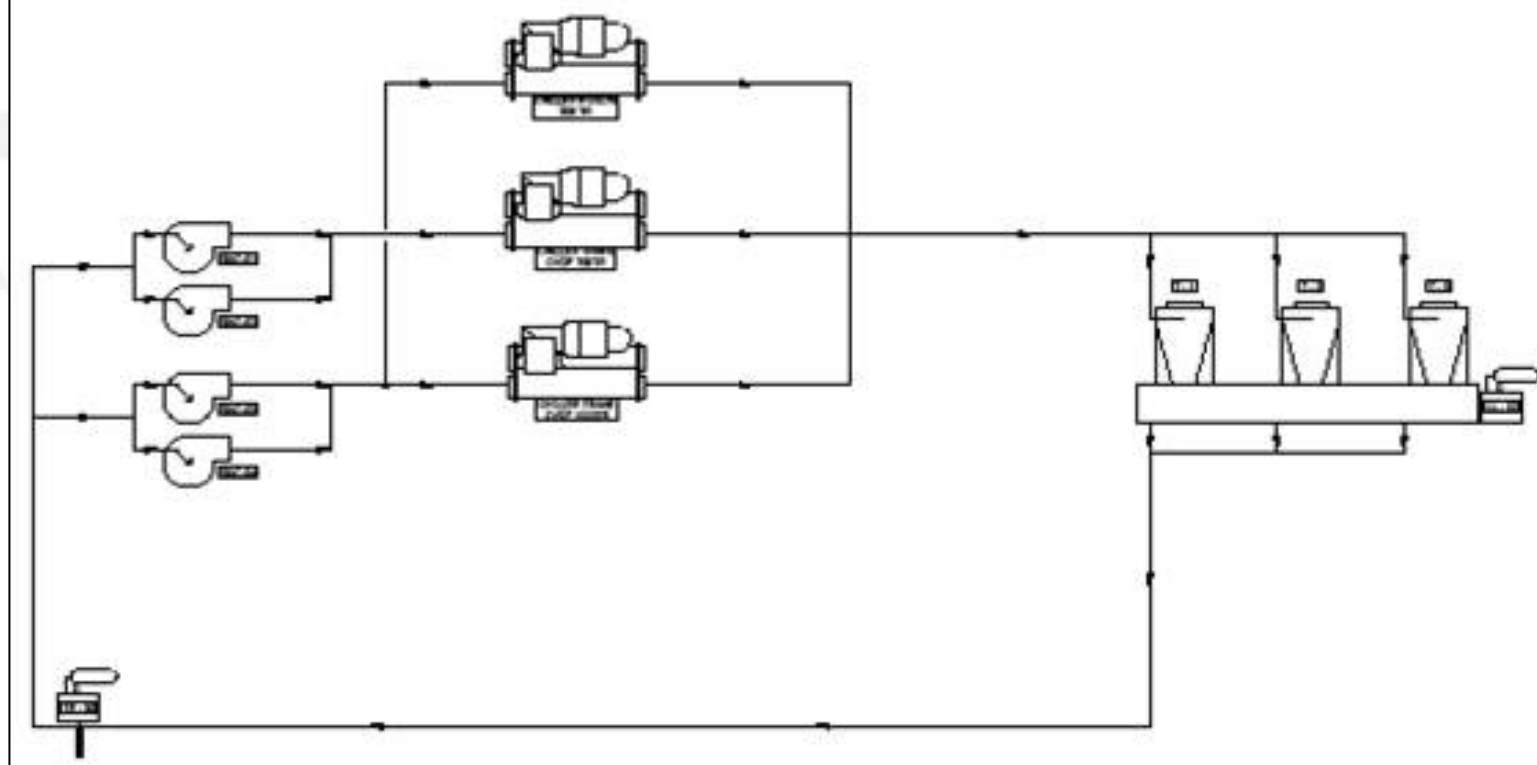

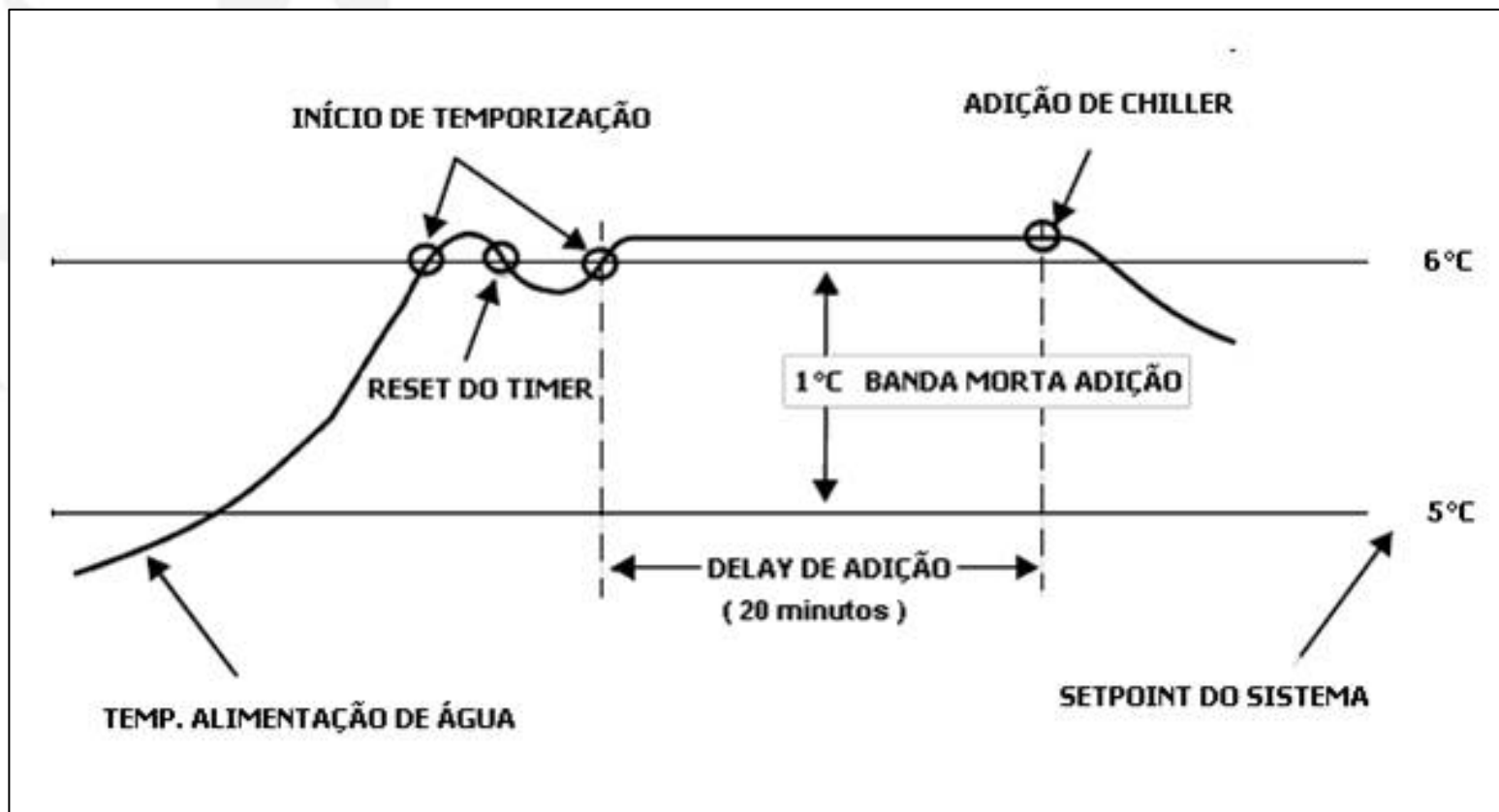

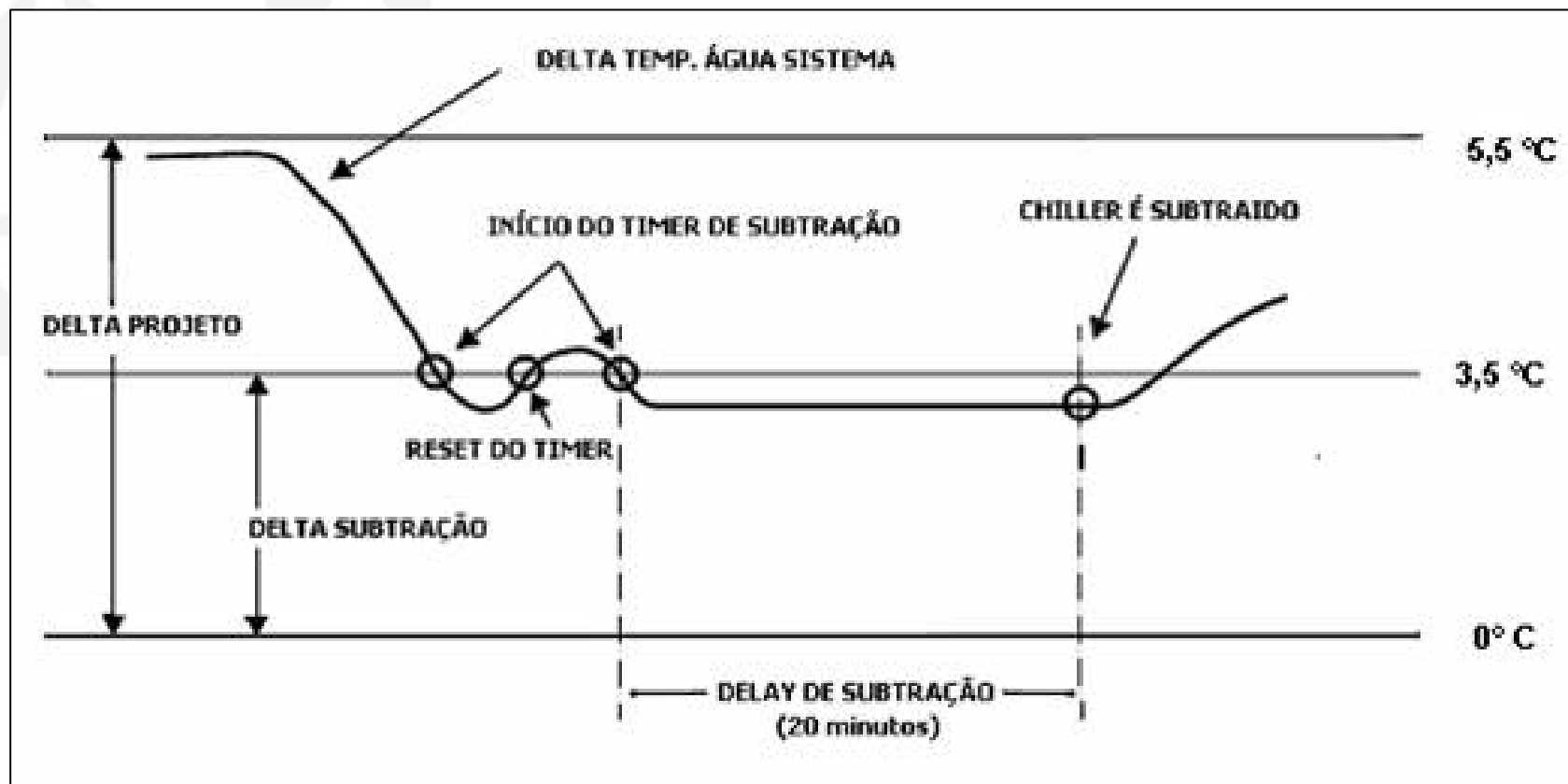

<b>SEQÜÊNCIA</b>	<b>EQUIPAMENTO</b>	<b>TOTAL</b>
<b>STEP 1</b>	<b>HITACHI (300TR)</b>	<b>300 TR</b>
<b>STEP 2</b>	<b>CVGF(720TR)</b>	<b>720 TR</b>
<b>STEP 3</b>	<b>CVGF(720TR) + HITACHI (300TR)</b>	<b>1020 TR</b>
<b>STEP 4</b>	<b>CVGF(720TR) + CVHF(1000TR)</b>	<b>1720 TR</b>
<b>STEP 5</b>	<b>5 CVGF(720TR) + CVHF(1000TR) + HITACHI (300TR)</b>	<b>HITACHI (300TR) 2020 TR</b>





# Central de Equipamentos Térmicos



# Caldeiras



# Áreas Atendidas



CME



SND



Trocador Bloco B



Boiler Bloco C



# Cenário Atual



**CALDEIRA**

**Demanda de vapor = 364 t/mês**

**Capacidade instalada = 1881 t/mês**

**Utilização = 19,3%**



**Aquecimento de água blc. C**

Consumo de vapor = 105 t/mês

Consumo de vapor = 105 t/mês



**Aquecimento de água blc. B**

Consumo de vapor = 20 t/mês



**SND**

Consumo de vapor = 117 t/mês



**CME**

Consumo de vapor = 122 t/mês



# Lay out esquemático atual

Área ocupada pela central térmica = 575 m<sup>2</sup>

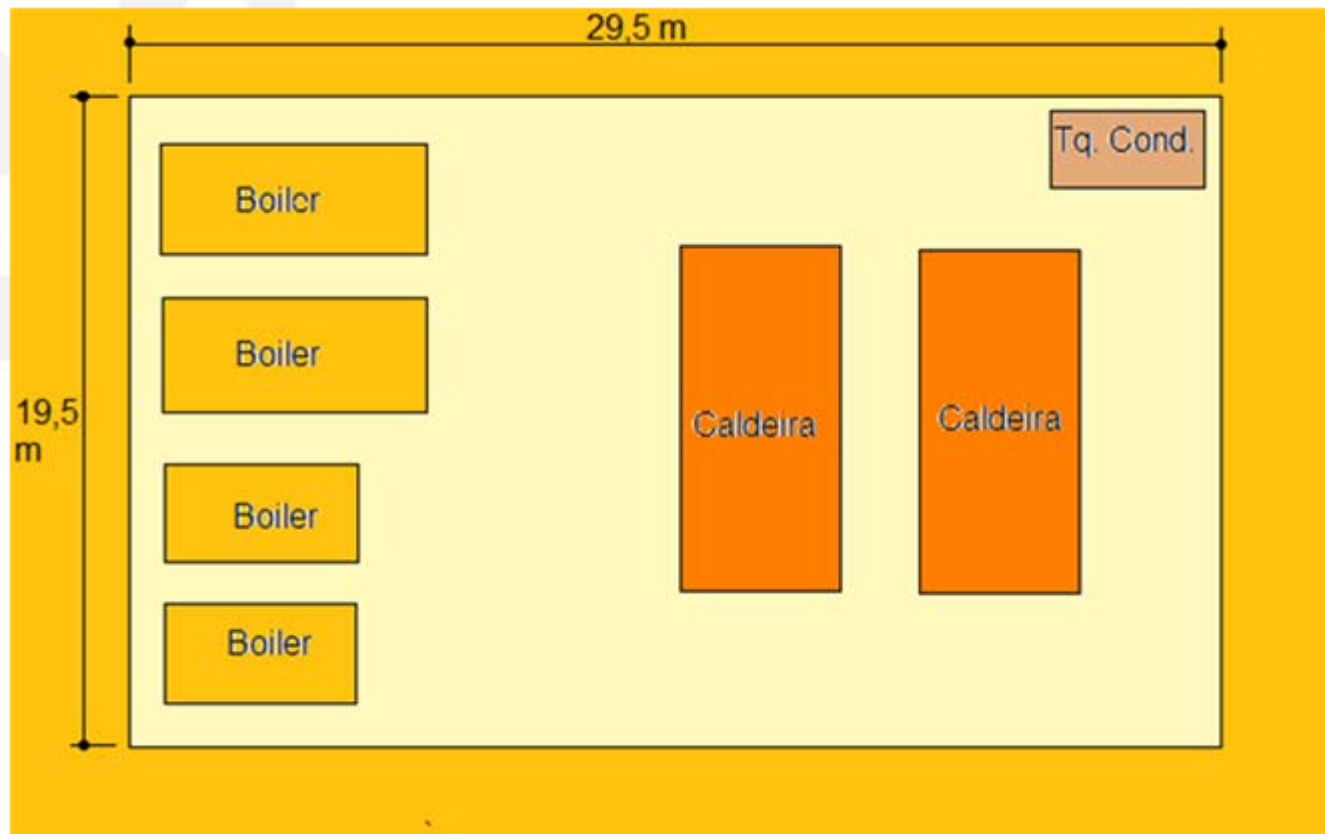

# Metas

- ◆ Liberar área de 575 m<sup>2</sup> no 5<sup>o</sup> subsolo do bloco C, ocupada pelo sistema centralizado de geração de vapor e água quente, criando espaço para a expansão da subestação principal.
- ◆ Utilização do calor da água de condensação da Central de Água Gelada para reduzir o custo operacional dos processos que utilizam vapor
- ◆ Mitigar o impacto ambiental pela redução da emissão de CO<sub>2</sub>.



## Fluxograma Água de Condensação

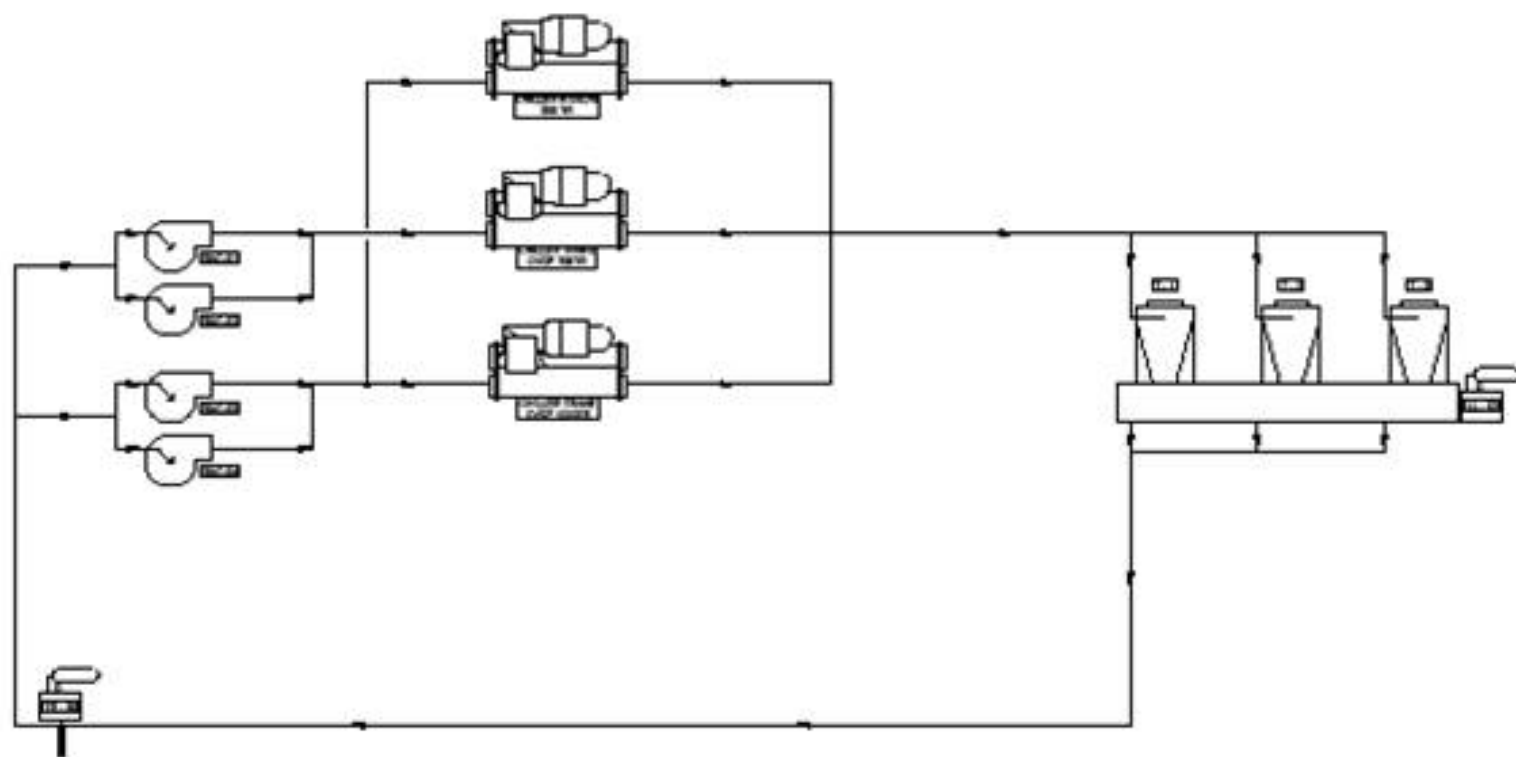

# Escolha da tecnologia alternativa ao uso do vapor centralizado

## Aquecimento de água

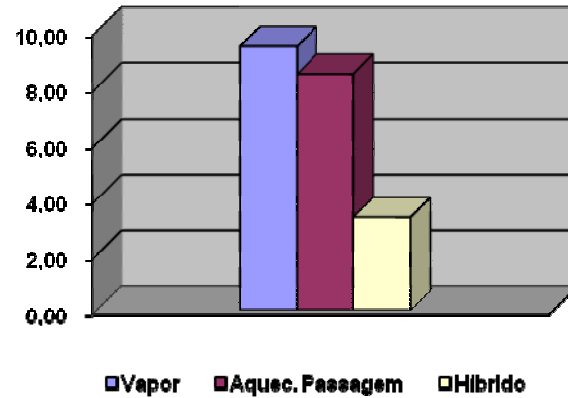

Tecnologia	Taxa (R\$/m³)
Aquec. por vapor	9,45
Aquec. de passagem	8,47
<b>Híbrido</b>	<b>3,34</b>



# SND – Serviço de Nutrição e Dietética

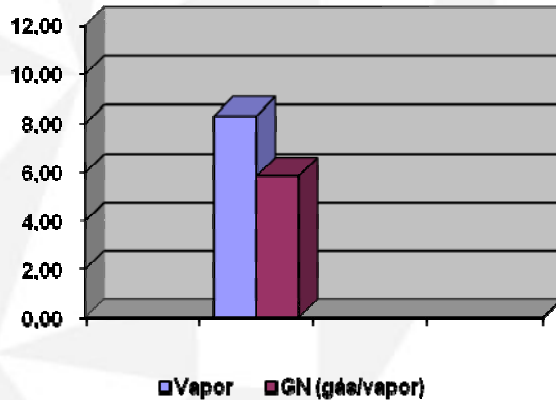

Tecnologia	Taxa (R\$/h)
Aquec. por vapor	7,84
GN (gás/vapor)	5,85

**Atual:** cocção composta por 3 (três) caldeirões a vapor não auto clavável, com capacidade unitária de 200 litros.

**Proposto:** substituir os caldeirões a vapor por gás-vapor (chama direta) com capacidade de 300 litros com tampa auto clavável.

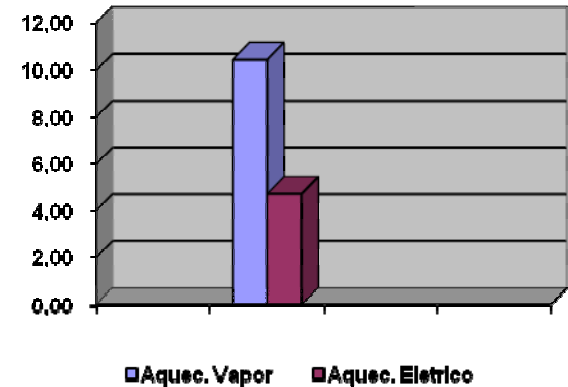

Tecnologia	Taxa (R\$/h)
Aquec. por vapor	10,46
Aquec. elétrico	4,71

**Atual:** Área de lavagem composta por dois equipamentos operando com temperatura de enxágüe de 85°C e consumo de água de 800 L/h. Massa de água aquecido por vapor.

**Proposto:** Substituir o modo de aquecimento de água para sistema elétrico, operando com temperatura de enxágüe de 85°C e consumo de água de 600 L/h. A instalação prevê a utilização de água quente proveniente da central térmica a uma temperatura de 65°C.



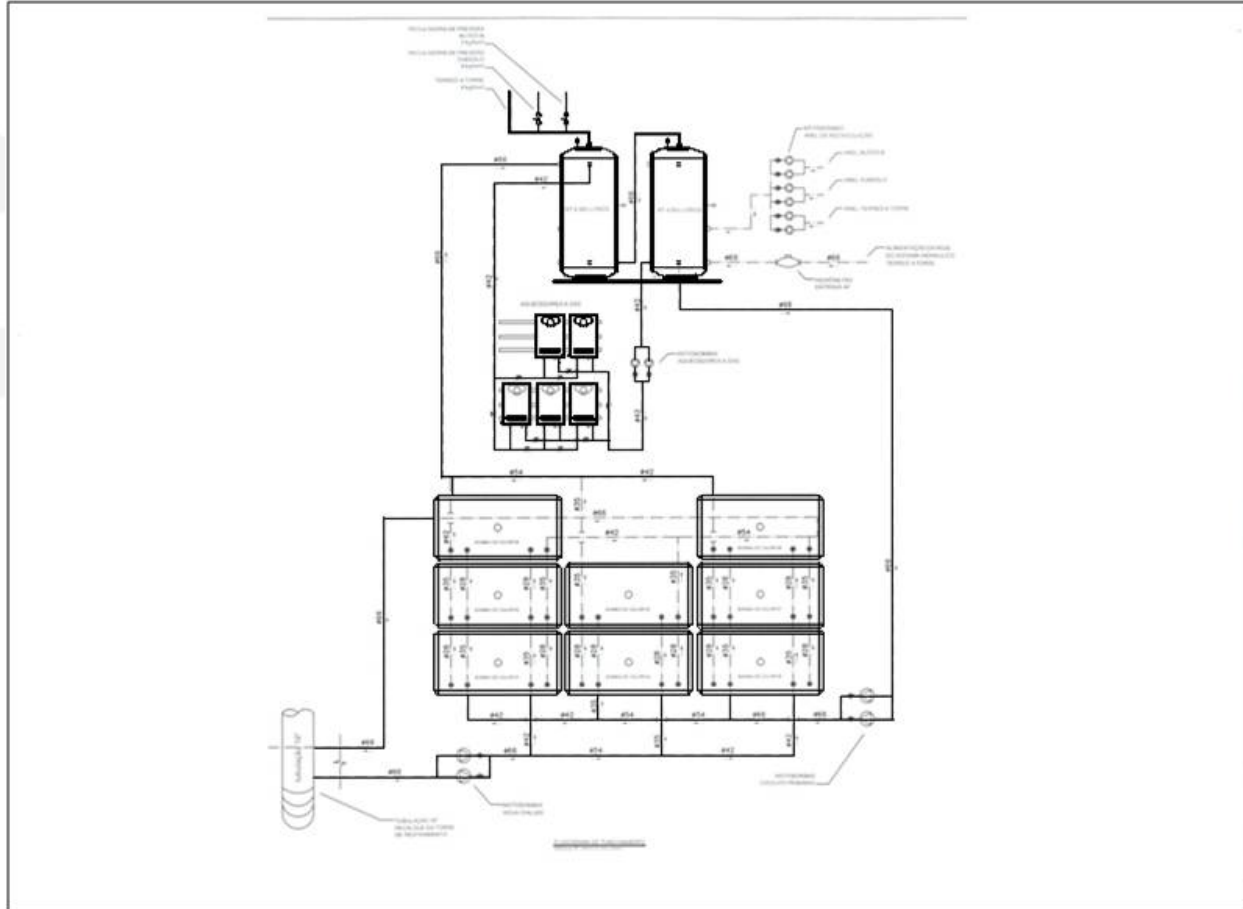

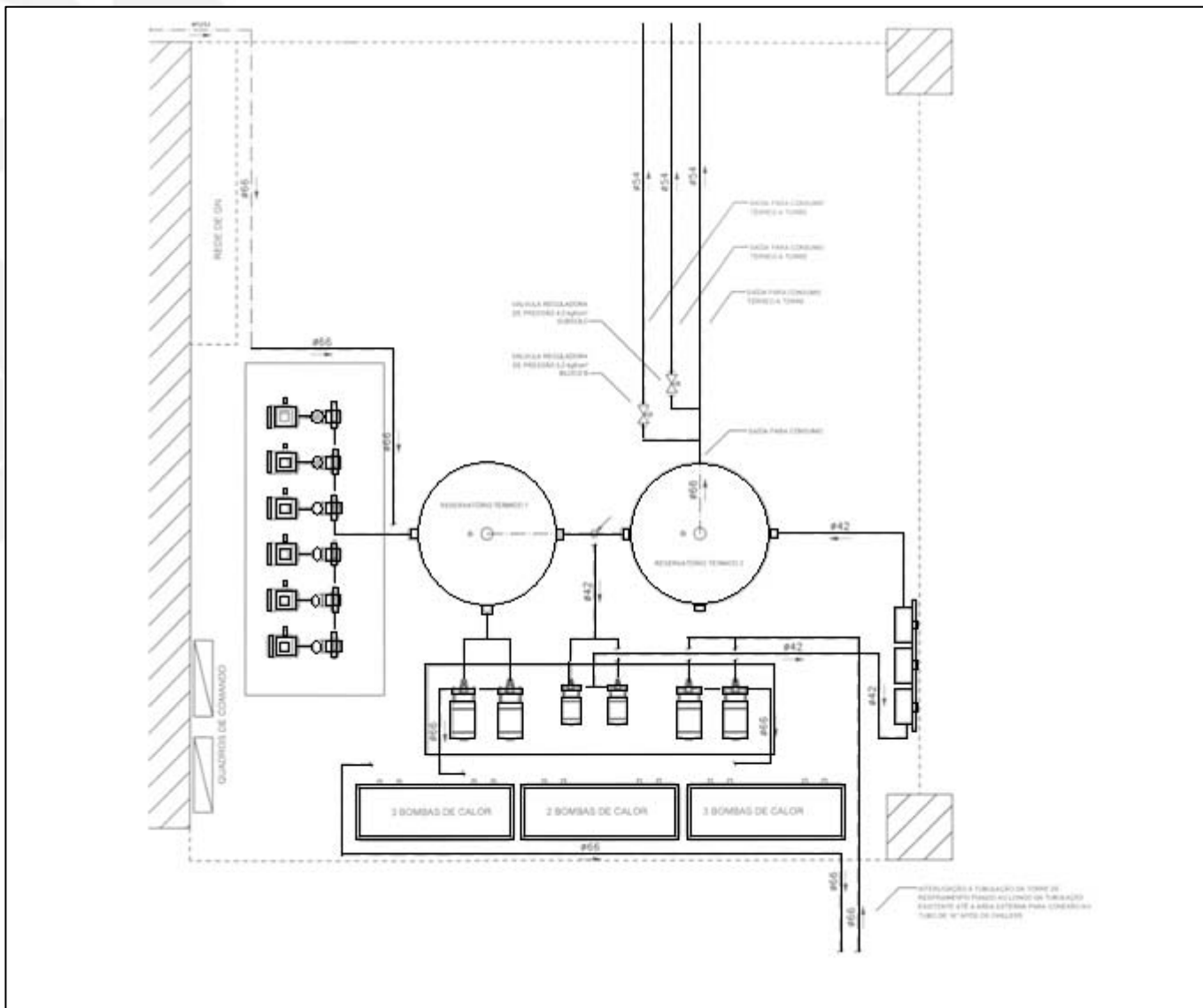





## Comparativo entre Cenário A e Cenário B

	Cenário A		Cenário B	
	Custo Operacional (R\$/mês)	Impacto Ambiental (kgCO2/mês)	Custo Operacional (R\$/mês)	Impacto Ambiental (kgCO2/mês)
Total/mês	39.450,95	24.317,84	15.863,74	13.687,03
Total/mês	473.411,40	291.814,08	190.364,88	164.244,36
Redução no Custo Operacional (%)	57,32			
Redução no Impacto Ambiental (%)	43,72			





# **Aproveitamento da água de rejeito de sistemas de Osmose Reversa**







**Parceiros:**

**Trane do Brasil**

**Masstin Engenharia e Instalações Ltda**

**Jelly Fish**

**Water Works**



Obrigado.

14/10/09



**HOSPITAL  
SÍRIO-LIBANÊS**